

The FICSIT Inc. Plumbing Manual: A Guide to Pipelines

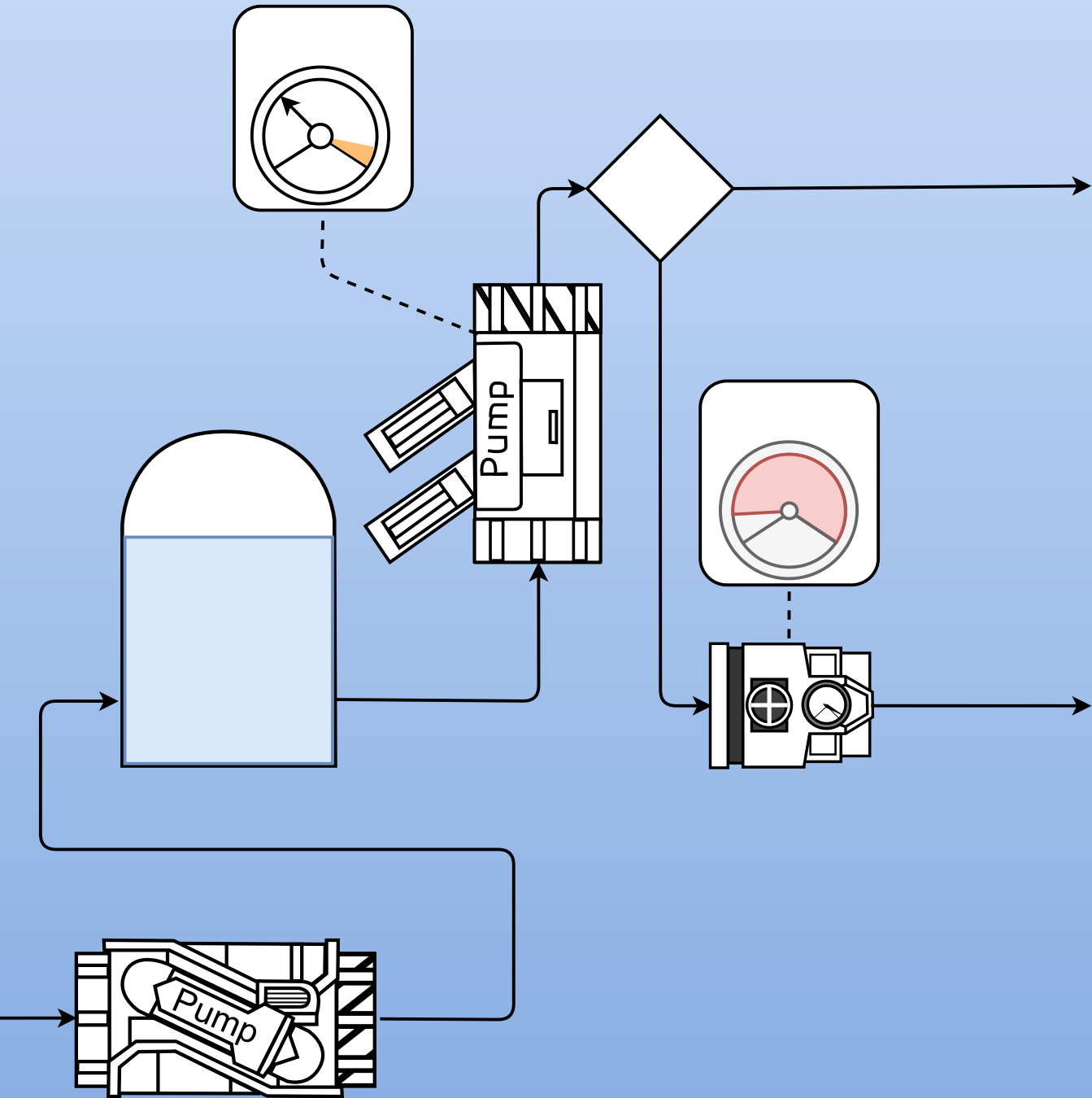

Plumbing Manual: Overview

Made by: @McGalleon#8273 (Discord)
u/MkGalleon (Reddit)

Index:

1. Pipe Basics	Page 2 - 6
L-1 General Pipe Info	Page 3 - 4
L-2 Pressure (Head Lift)	Page 5
L-3 Flow Management	Page 6
L-4 Pumps	Page 7 - 8
L-5 Buffers	Page 9
L-6 Valves	Page 10 - 11
L-7 Troubleshooting	Page 12
2. Advanced Piping	Page 13 - 14
L-8 Manifolds	Page 13
L-9 Recycling By-Products	Page 14
3. Special Circuits	Page 15 - 17
L-10 Flow Rate Filters	Page 15
L-11 Variable Priority Junctions	Page 16
L-12 Head Lift Tricks	Page 17
L-12 Sample Solutions	Page 18

Manual Version: 1.4
Date: 21.08.2022
Current Game Version: Update 5 + Update 6 (+ onward)

Legend:

Blue Boxes usually contain important information

Gray Boxes are small questions for you to think about

Green Boxes contain the answers to the questions

Red Boxes contain Warning Texts - **Keep these in mind!**

Yellow Boxes contain more detailed explanations and infos



Lesson 1: Pipe Basics - General Pipe Behaviour

Pipelines in Satisfactory are overly simplified compared to real pipes. They have these properties:

- **Bidirectionality:** Pipes have no preferred direction. Fluid can flow both ways through a pipe.
- **Gravity-Bound:** Pipes will always flow down first, if possible.
- **Pressure-Based:** Pipes use Pressure to generate movement of fluid - the Flow Rate.

These properties lead to the following behaviour:

- Pipes build up Pressure as they fill. The more they are filled, the faster they flow. (1.2 m Head Lift)
- The Fluid in Pipes will flow from places of high pressure to low pressure - from full pipe to less full pipe
- Until a Pipe's internal Volume is full, it can't transmit Head Lift from machines or pumps.

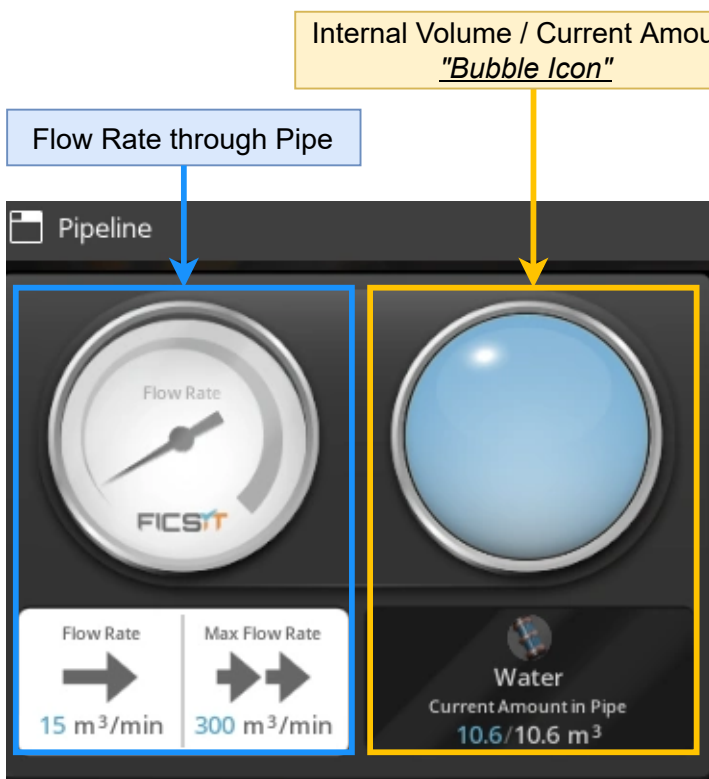

- The Flow Rate is the amount of fluid that is flowing through the pipe per minute.
- The Max Flow Rate is the limit of the pipe: It can't flow any faster than this
- The Current Amount in Pipe is the internal volume - it shows how full the pipe is.
- A pipe can only **flow at maximum speed if it is full.** At **50% full** it can only **flow half as fast.** (Example: Mk. 1 Pipe with 6/10 m³ amount - it will only flow at 180 m³/min)
- The Flow Rate tends to fluctuate - **the true flow is the average flow over time**

Mk. 1 Pipes can handle 300 m³/min maximum
Mk. 2 Pipes can handle 600 m³/min maximum

All this can be simplified to one easy rule:

Full Pipes are happy Pipes

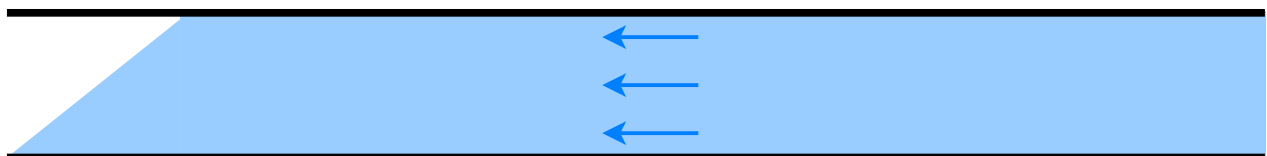

As long as you make sure the Bubble Icon is full, Pipes should not behave in weird ways

Lesson 1: Pipe Basics - Knowledge Question 1

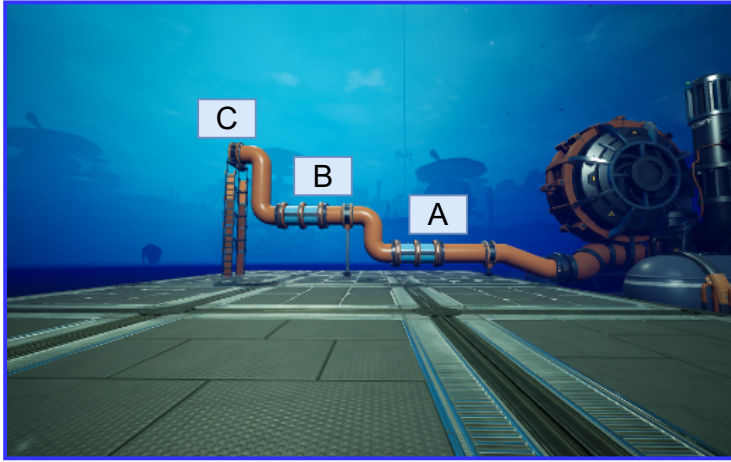

Hopefully you will be able to answer this question at this point:

In which order do the pipes fill up in this picture?

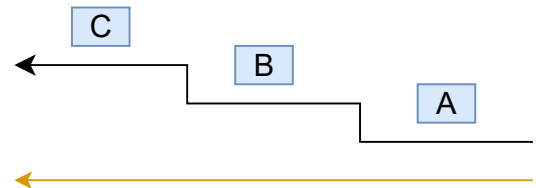

Of course the order is *A, then B, then C.*

This is because of gravity.

Until A is completely full, there is not enough Pressure to fill B and also not enough for C.

Pressure makes fluids flow from full to empty pipes



How about this:

This is the UI of a Water Extractor.

It's set to 100% Clock Speed.

That means it should produce 120 m³/min.
(The orange number on the left)

**So why is it flowing at 300 m³/min?
And what do the 600 m³/min mean?**

The **Max Flow Rate** is the maximum speed at which pipes can flow and machines can empty themselves.

The **Flow Rate** is the speed at which it currently outputs fluid.

If you paid attention, you will know that **pipes will try to flow at maximum speed if they are full.**

Machines do this all the time.

Everytime a machine produces fluid, it tries to empty at maximum speed (depends on connected pipe).

This is why flow rate fluctuates in the output pipe. On average, it will equal to the target flow rate however.

So this Water Extractor will output at maximum speed until it is empty.

It can flow at 600 m³/min, but due to some limitation (like a Mk.1 Pipe or a Valve), it only empties at 300 m³/min.

Lesson 2: Pipe Basics - Pressure

Pipes have 2 kinds of pressure: **Head Lift** and **"Work Pressure"**

We will only talk about Head Lift as Work Pressure is not easily manipulated or noticeable

Head Lift determines the maximum height fluids can flow to.
It is transmitted through **full pipes** and does not decline in them.
(The exception is unpowered Pumps: they block Head Lift. Valves do not).

Since Head Lift is only for verticality, horizontal pipes don't need it to keep Flow Rate up.

Note that **gas does not have Head Lift** - the Flow Rate just **depends on how full a pipe is**.
This means Pipeline Pumps do not work. Buffers also cannot compensate the Flow Rate,
because Buffers depend on Head Lift to output fluid at maximum Flow Rate.

However, it may still be a good idea to place a pump on a horizontal pipeline (not for gas).
Why? Because it reduces the time it takes for fluid to reach the destination

In a pipeline shapes like this, putting a pump in the "valleys" will help speed up filling times.

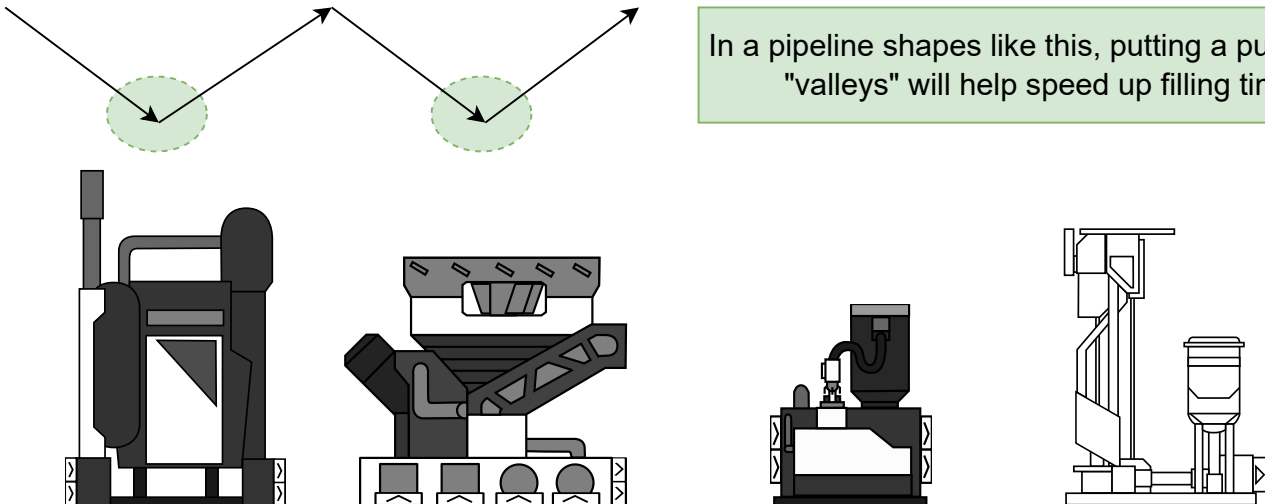

Normal Machines (like Water Extractor, Freight Platform, etc.) produce **10 m of Head Lift**

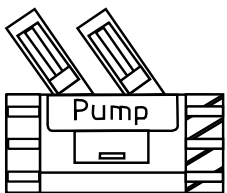

Pumps Mk.1
produce
20 m Head Lift

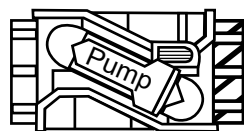

Pumps Mk.2
produce
50 m Head Lift

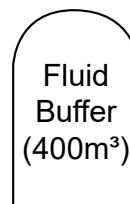

Fluid Buffer
(400m³)

Buffers produce Head Lift based on fill height: Small - 8 m, Large - 12 m
If they are not full, it will be less

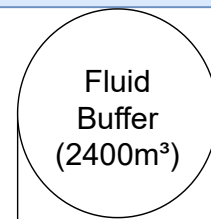

All Machines have a tolerance of ca. 12%:

- Normal Machines: 12 m Head Lift total
- Mk.1 Pump: 22 m Head Lift total
- Mk.2 Pump: 55 m Head Lift total

If you go above the maximum Head Lift, the Flow Rate will be reduced to 0 m³/min.
Build your Factories so you aren't near the limit.

Lesson 3: Pipe Basics - Flow Management

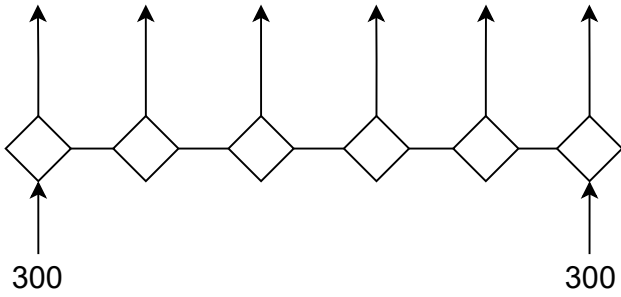

This setup has been built with a Mk.1 Pipe
 Mk.1 Pipes can only carry 300 m³/min.
 Each output pipe needs 100 m³/min.
Will it work?

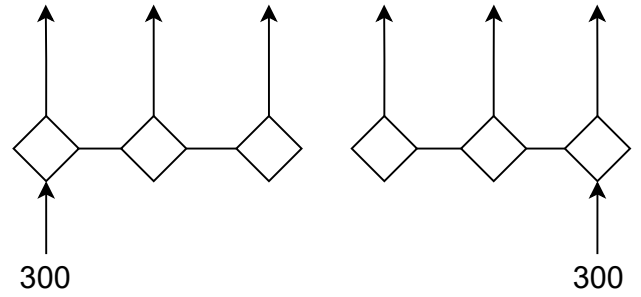

If your answer was yes: you are correct!
 the 300 m³/min on the left are exactly enough
 to feed the first 3 outputs, same for the right side.

In fact, the middle Pipe isn't even needed,
 so it can be built like above.

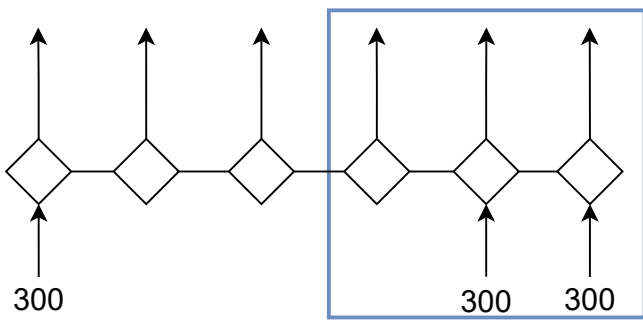

What about this network then?
 Each output needs 150 m³/min

It might seem like there will be bottleneck issues,
 but that's not correct. The reason?
Junctions have no Flow Rate limit

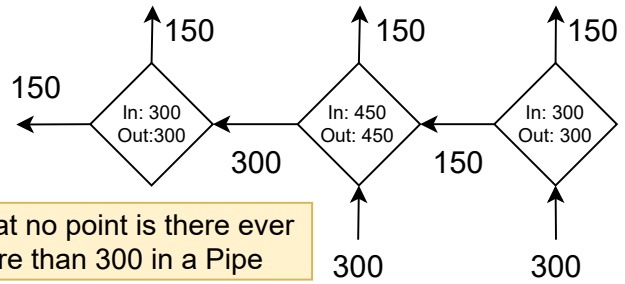

See? at no point is there ever
 more than 300 in a Pipe

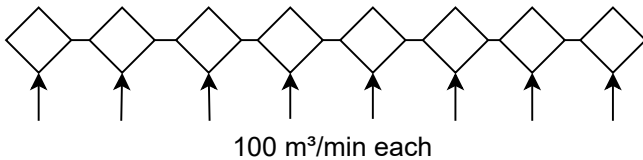

Now here is something different: 8 Pipes, each inputs
 100 m³/min, so 800 m³/min total.
 How many pipes are needed to transport this off?

Just use 3 output Pipes!

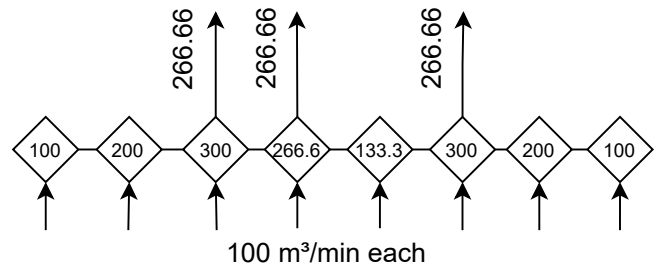

The reason these numbers look weird is because
Pipes try to have equal pressure everywhere.
 Here, Work Pressure divides over 3 Outputs
 so each Output gets 800/3, which is 266.666

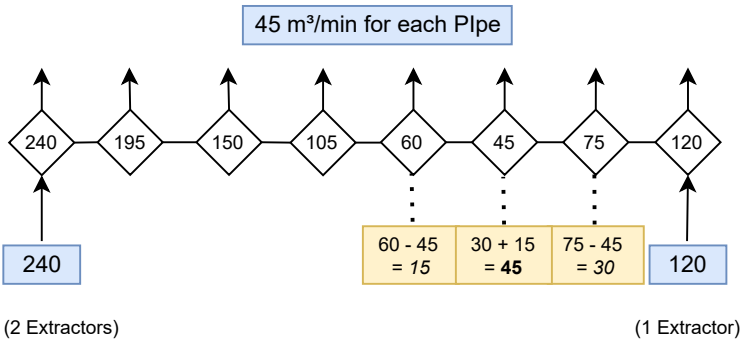

This pipe network should be familiar to you:
 it's the ideal **Ratio for Water Extractors to
 Coal Generators (3:8)**
 And once again: nowhere does any Pipe ever
 exceed the 300 m³/min limit.

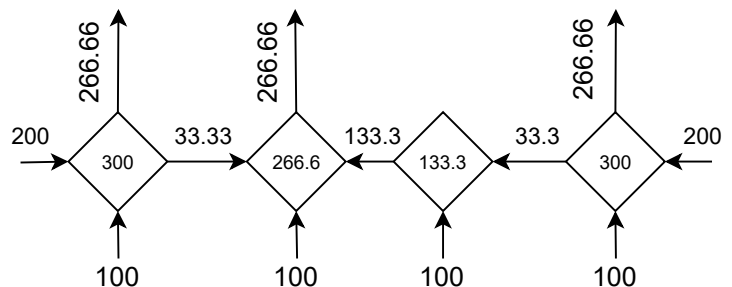

This should make it easier to understand

Lesson 4: Pipe Basics - Pipeline Pumps

Pipeline Pumps are attachments that *increase the Pressure inside a Pipeline*.

They don't increase Flow Rate and are not needed on pipelines that do not move up vertically.

Head Lift from Pumps does not stack, but it does stack with **Head Lift gained from gravity after the pump.**

Pumps also do these things:

They prevent backflow - they are one-directional

They generate a blue hologram ring - it stops where their Head Lift ends

They have no Flow Rate limit - you can use Mk.1 and Mk.2 pipes with them

They snap to the hologram ring of other pumps

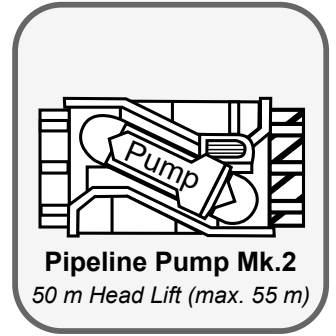
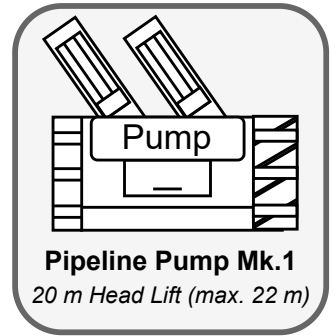

Pumps also apply Head Lift when they are on the **horizontal part of a pipeline** - it will rise once the pipe starts going up.

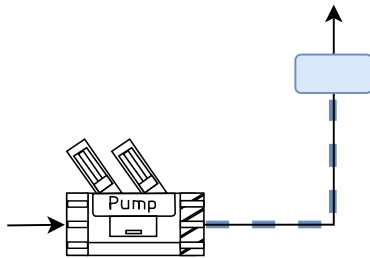

This ring appears when you snap a Pump to a Pipeline. It usually stops where the Pump's Head Lift ends.

It can only travel 100 m, so if you have a long diagonal Pipeline, you might not see it stop.

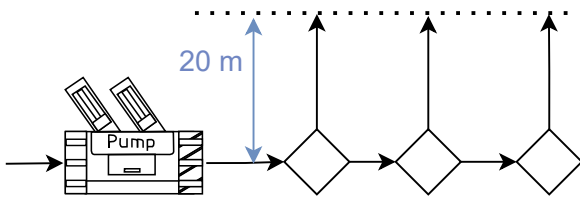

All 3 Pipes can rise up 20 m together

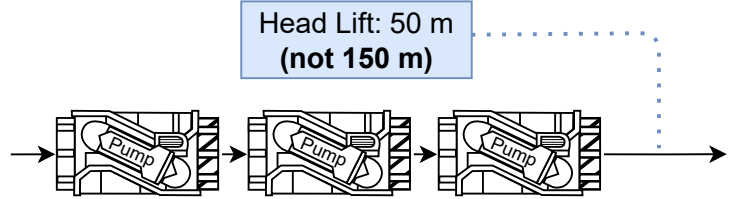

Head Lift: 50 m (not 150 m)

Head Lift from Pumps does not stack. Leave vertical distance between them!

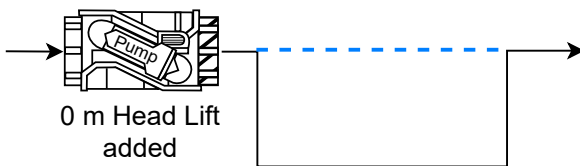

Pipes that **dip** and then **rise back to the same height** do not need pumps: they gain their pressure through *gravity!*

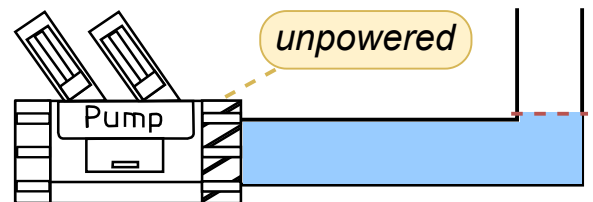

Pumps that are not powered **set the Head Lift on the exit side to 0 m!** They still allow fluids to pass through.

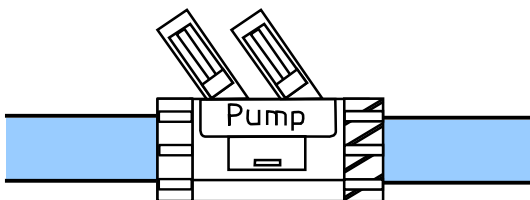

A Pump will show **about 1.5 m Head Lift on a flat horizontal pipe.** This is the *default Pressure*.

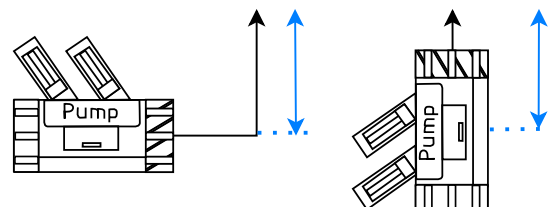

Head Lift gets measured from the *center of a Pipe or Pump*. It's measured upwards, never downwards. **(Fluids flow down on their own, they don't need to be pushed down)**

Lesson 4: Pipe Basics - Knowledge Question 2



The Pipe here has 2 bumps: the first one is 18 m tall, the second one 22 m.
The pump sits 9 m high on the first pipe.
Will it be enough for both bumps?

If you carefully read the last page, you will remember that **Pump Head Lift and gravitational Head Lift stack (only after the pump)**.

The Pump will at first apply 9 m of Lift. After that, the pipe goes down, which is where gravity will take over.
After the pipe has risen back to its original height, the pump takes over again and applies an additional 4 m.

So the Pump only needs to pump the Water 13 m up!

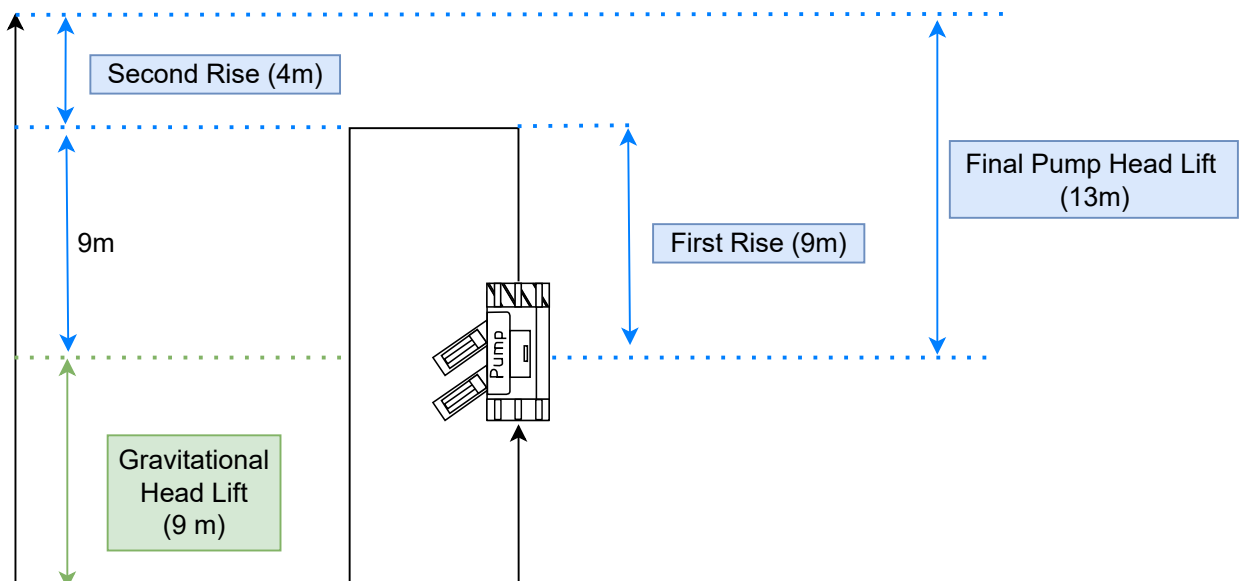

Lesson 5: Pipe Basics - Fluid Buffers

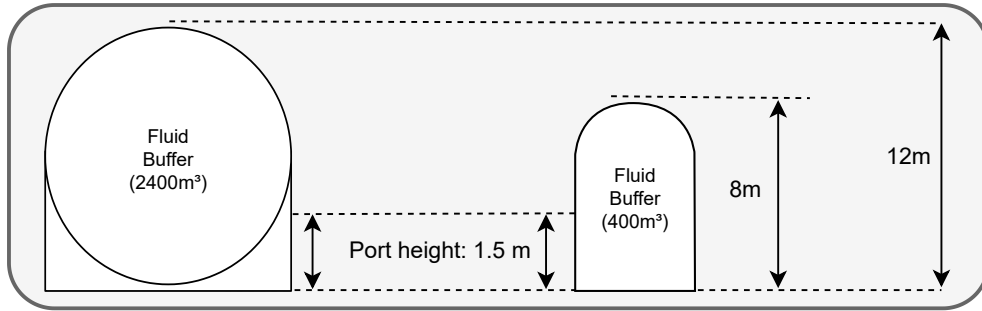

Fluid Buffers are structures that **allow the storage of fluids**.

To fill a Buffer, the Pipe connected to it needs to be able to supply a Head Lift equal to the Buffer's height.
(8 m for the small Buffer, 12 m for the industrial Buffer.)

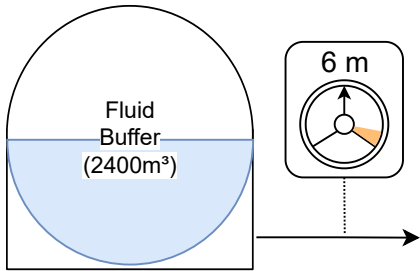

Buffer Head Lift is **proportional to the amount of fluid inside them**:
a half full industrial Buffer generates 6 m of Head Lift and a small Buffer generates 4 m Head Lift

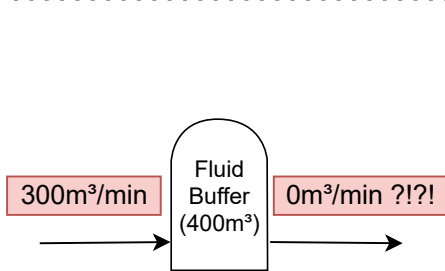
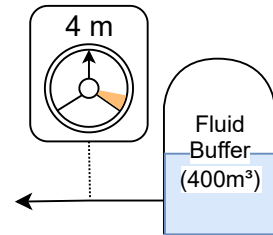

Filling and emptying a buffer has a small limitation:
Unless it has a Head Lift of 1.5 m, it won't output the fluid as fast as it flows into it

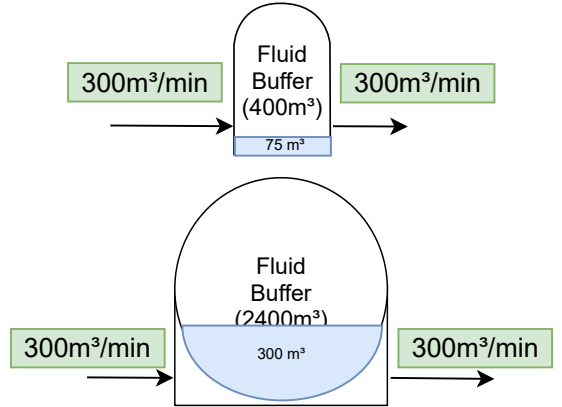

To get at least 1.5 m of Head Lift:

- The small Buffer needs **75m³ inside**
- The industrial Buffer needs **300m³ inside**

Serial Buffers

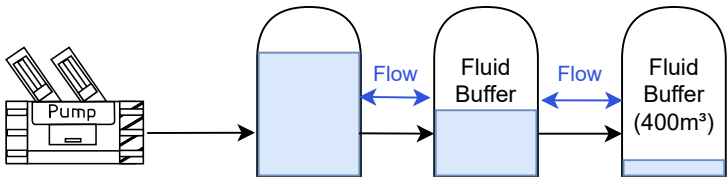

Buffers connected with each other try to balance themselves.
 Connected **in series**, this leads to **heavy sloshing**.
 Connected **in parallel**, this odd sloshing is mostly resolved.

Parallel Buffers

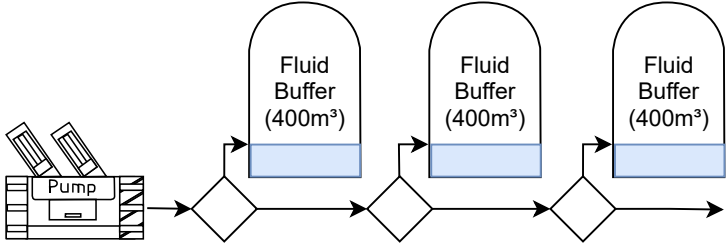

Buffers find their main usage for production lines **where output is very discontinuous** (like Fluid Freight Platforms) **or fluctuates a lot**.
 There's also more specialized usages in **Regulation Circuits** (*See: Special Circuits - Lesson 9*).

Lesson 6: Pipe Basics - Valves

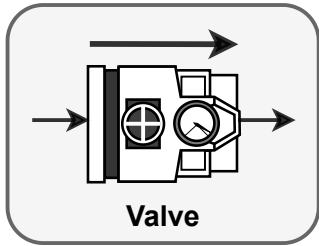

Valves are Pipe attachments that **don't allow backflow** and make it possible to **limit Pipe Flow Rate**

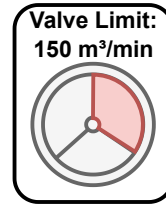
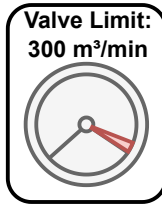

A different Value can be set **by moving the slider or entering a number. (Press Enter to confirm!)**

Valves have a slight display bug: the Flow Rate they show is inaccurate, but it usually works (if used correctly)

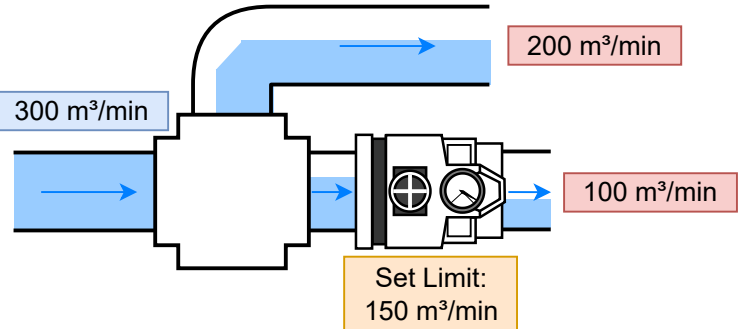
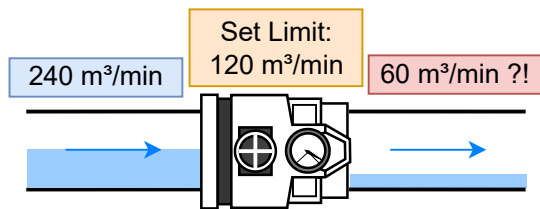

When the *Pressure inside a Pipe isn't big enough* (that is, when the Pipe isn't full), **Valves output less than the Limit they are set to.**

This issue is even worse on **Pipes with insufficient Flow Limiting**. Most of the fluid goes to the Pipe without a Valve!

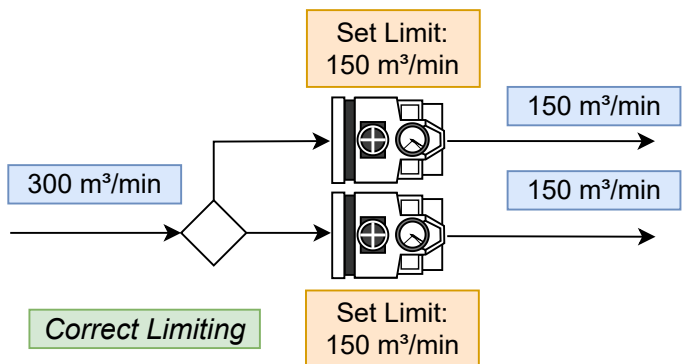
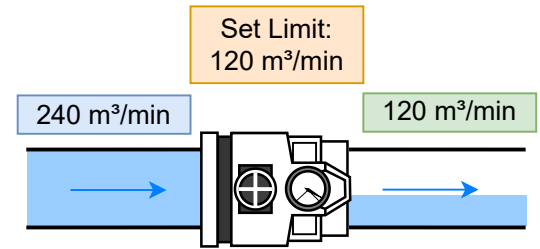

Once the Pipe is full (and the Pressure is big enough again) *the Valve works as intended.*

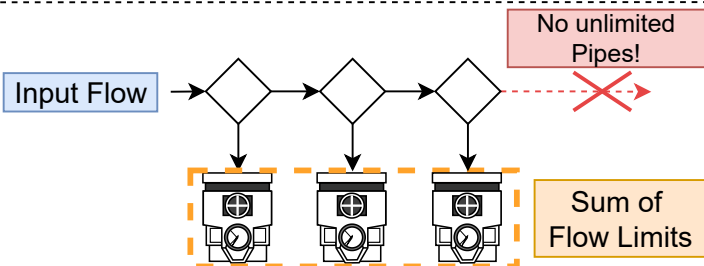

Make sure that when Flow Rate is split among many Pipes:

Input Flow = Sum of Flow Limits

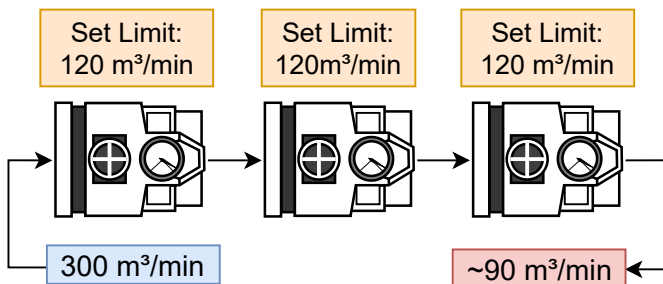

Many Valves in series suffer from the same issues: *Until the Pipe on their input side is full, they don't output at the set Flow Rate. This adds unnecessary delays.*

Valves in series *do not reduce the possible Flow Rate* though. *If the Pipes were full, the Pipe Network on the left would output 120 m³/min, as intended.*

Lesson 6: Pipe Basics - Knowledge Question 3

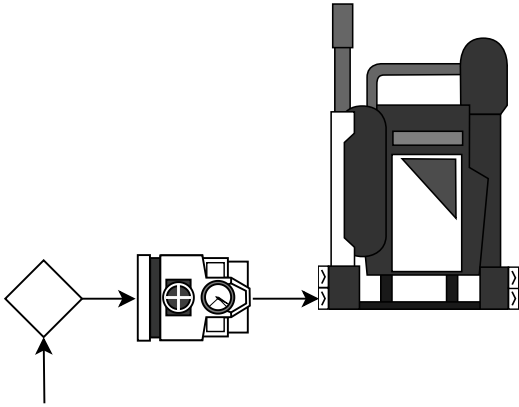

Assume you have a pipeline feeding a machine. On the input side there is a valve to prevent backflow.

Now assume the machine becomes full and the input pipe starts filling up.

What do you expect to happen to the input pipe before and after the valve?

This question is meant to test your expectations on how fluids act. This case becomes very important for pipe networks that carry 600 m³/min in one pipeline.

Assume that a valve is like a normal non-return valve. There is a "door" inside that prevents fluid from going back.

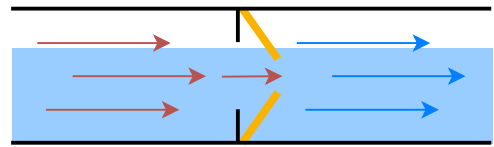

The output pipe of the valve will fill up, but once it's full the valve can no longer output more fluid. In that case...

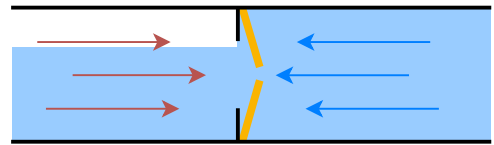

...both the valve input and output will fill up. However, fluid has a desire to move. That means....

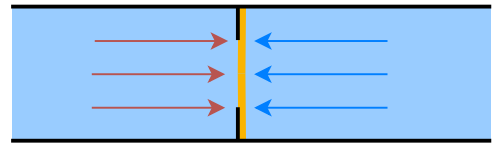

....it will switch flow direction! (This is similar to two objects colliding and bouncing off each other)

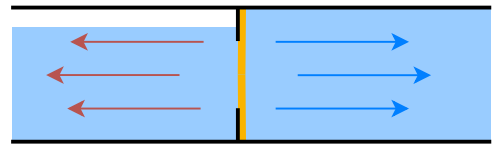

So the final answer:

From the outside, it will look like fluid is moving from the output side of the valve back to the input side!

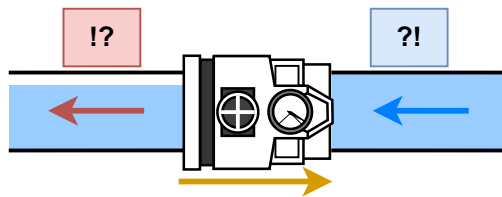

For Pipe networks at 600 m³/min input, this issue happens at the very first junction and is the reason they suddenly lose flow rate (with or without valves).

The fluid flows back into the junction and **interrupts the input.**

This issue can only be avoided by **not using full pipe capacity.**

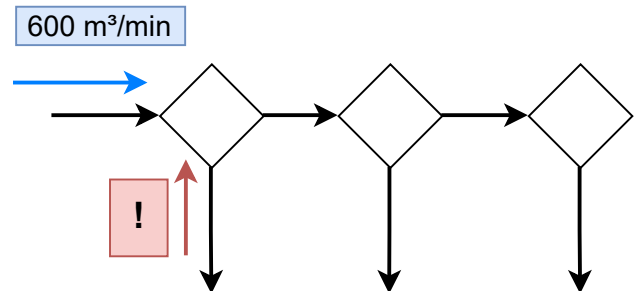

Lesson 7: Pipe Basics - Troubleshooting

Pipe issues can be divided into categories:

1) Connection Issues

This can be caused by missing or bad connections.

What is a bad connection? It usually looks like this:

This issue is resolved by rebuilding the pipes.

Pipe full,
Input ok

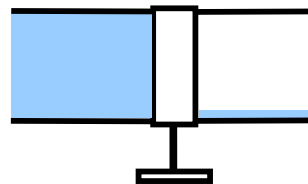

Somehow
empty

2) Head Lift Issues

Usually caused by overestimating the 10 m Head Lift from machines or by bad pump placement.

It might look like this:

Solving this problem means putting pumps at good locations and adding more if needed.

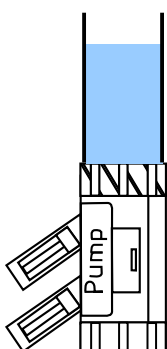

If the pump isn't exceeding Head Lift, then the pipe below it may be at fault.

Flushing the network may be useful for finding pipes that might have worked before, but now failed.

Snapping a pump to a pipeline leaves a bit of pipeline inside the pump - rebuild the pipe to reduce the length

3) Flow Rate Issues

This is a more complex issue. Only try and solve this if you are sure it is *not 1) or 2)*.

First, remember that pipes have volume. It takes time for them to fill. Pipes that are not full enough don't have the same flow rate as their input pipe.

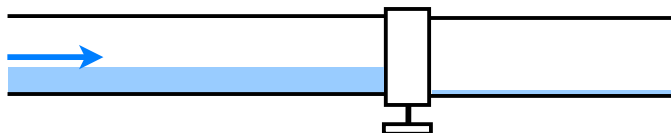

If you can, use short pipe networks. It's always easier to process fluids near their sources.

Second, make sure your math is right.

Don't just guess. If you are not sure how much a machine needs or produces, **go and check!**

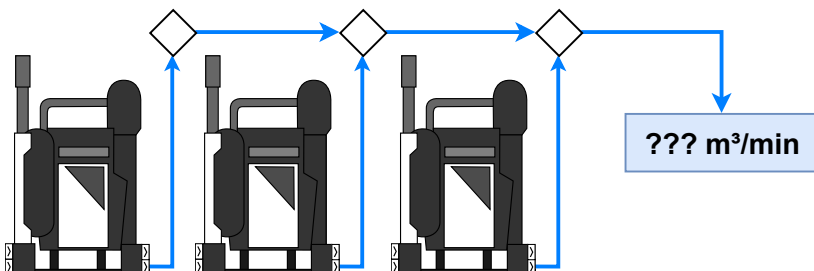

If **one of the outputs** of a machine with multiple outputs gets full, **it will stop producing**. You can delete fluid by dragging it into the trash can in your inventory.

Third, check the flow rate at multiple points along the pipeline. That way you can narrow down where exactly the problem is.

The **flush function** is useful for resetting a pipe segment and seeing if it fills and what the flow rate is at that moment. If the flow **still doesn't make sense**, it may be an issue **from a different Lesson**.

Lesson 8: Advanced Piping - Manifolds

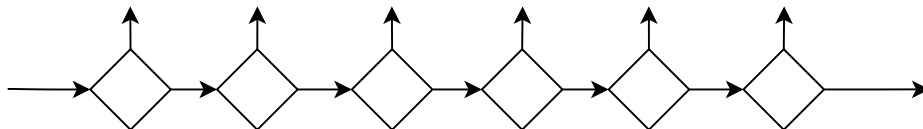
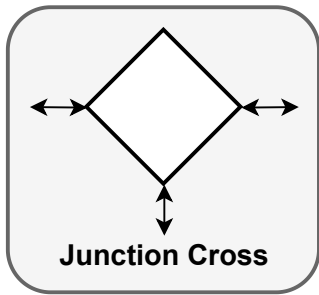

A manifold is any arrangement of Pipes and Junctions connected **in series**. Since Pipes (and Junctions) are bidirectional, they will ultimately balance themselves.

As easy as this may seem, there are certain rules to make them work right:

1. Always build your *Feed Pipeline level to or above the machine inputs*. Avoid building it below them!

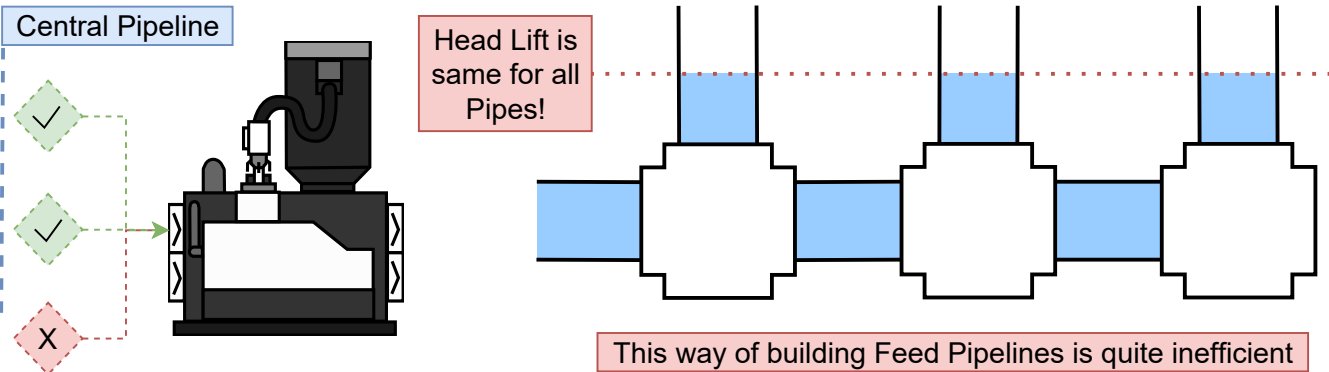

The reasoning is quite simple: no machine gets fed **until the entire pipe network has the same fluid levels**. The problem is that, *as soon as that level drops, no machine gets enough fluid anymore*.

2. Make sure to prefill the machines - A machine input can hold 50 m³ of fluid. Make sure it is full!

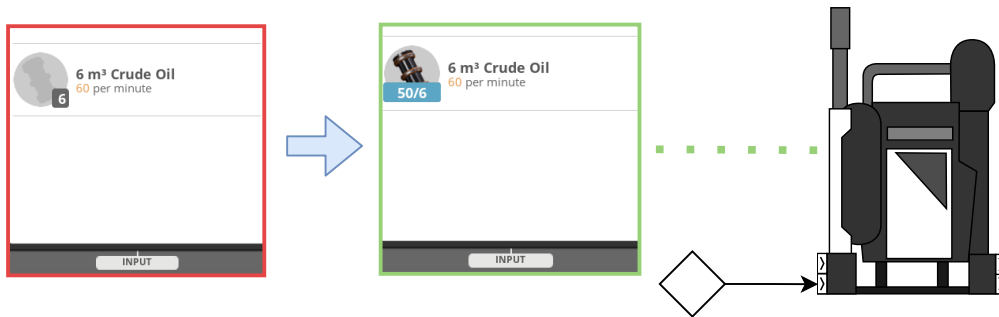

A full internal storage means the machine can only consume as much fluid as it needs

3. If you still have problems, turn the Pipe Network into a Loop - A loop is used to inject fluid from both ends and avoid losses.

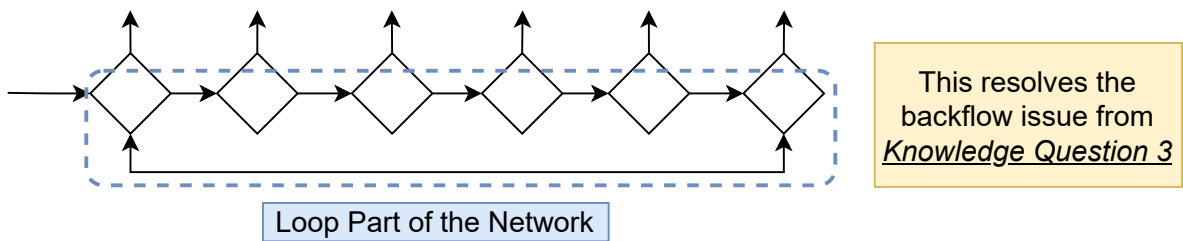

Most of these measures are currently **needed** for pipe networks at maximum flow rate (600m³/min). *In the future, this issue will hopefully be fixed.*

Lesson 9: Advanced Piping - Recycling Byproducts

Some Processes, like Aluminum, generate Byproducts (here: Water) that need to be dealt with

Usually Pioneers just try to feed the Water back to the first Refinery.
Can you see a problem in that?

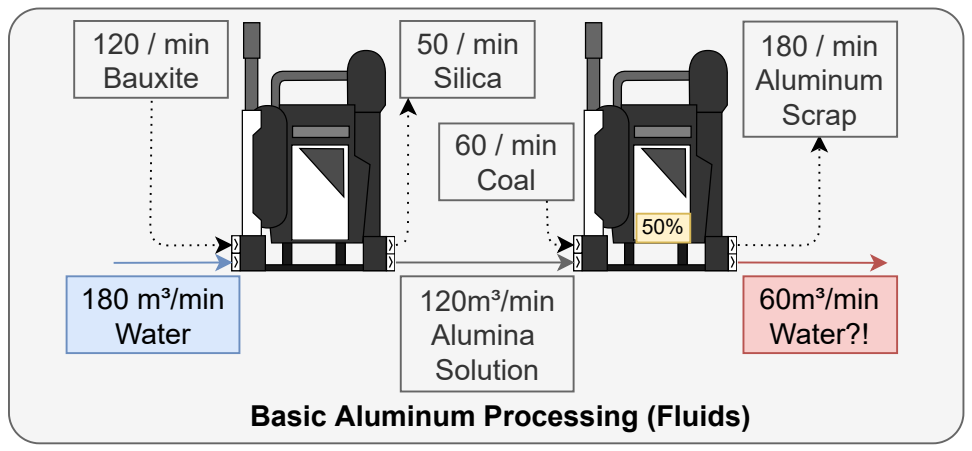

Without any additional work, the second Refinery would get clogged if its output pipe is simply connected to the first refinery's input pipe

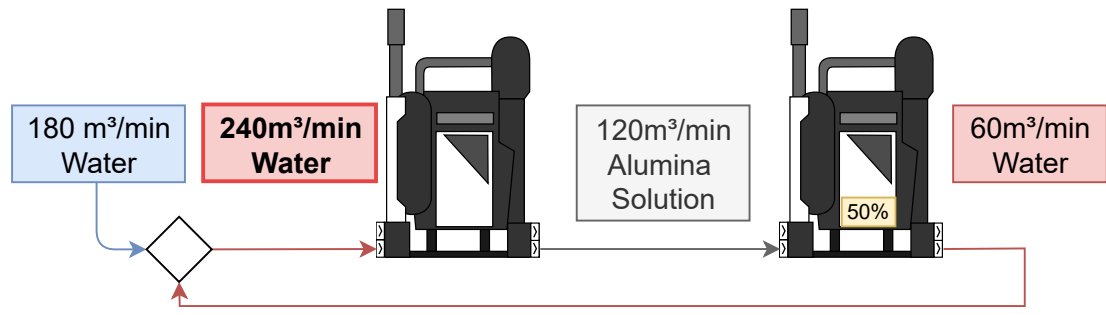

- There are a few ways to solve this:
1. **Underclock** the Water Extractors and also **limit them with a Valve** (for extra safety) (This solution only works if every machine runs at 100% efficiency, very unstable otherwise).
 2. **Dedicate some Refineries to only run on the Water byproduct** (the most stable solution)
 3. Feed the Water to **other Machines** (like Coal Generators)
 4. Package and sink it (**this is the worst solution**)

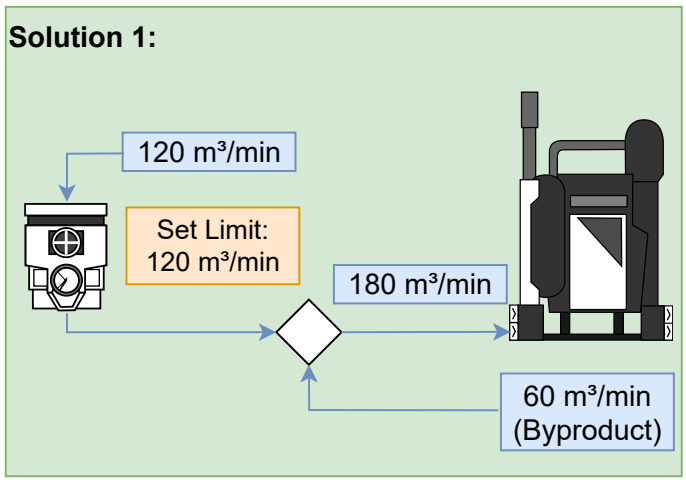

These are only 2 of the 4 Solutions. There are many variations to them, but these are the easiest ones.
*Alternatively, theres also a Special Circuit that can solve this: the **Variable Input Priority Junction** (Lesson 11 - Page 16)*

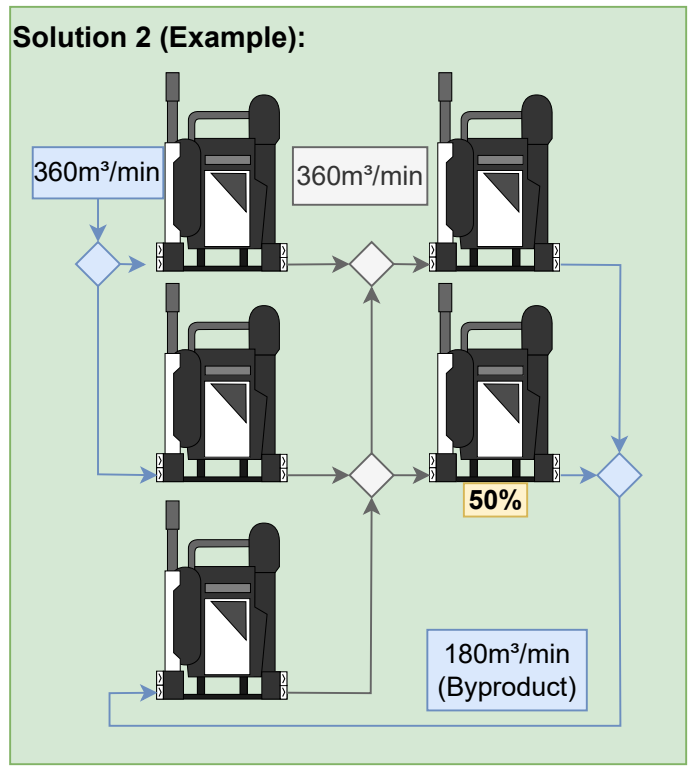

Lesson 10: Special Circuits - Flow Rate Filters



Flow Equalizer (sample build)

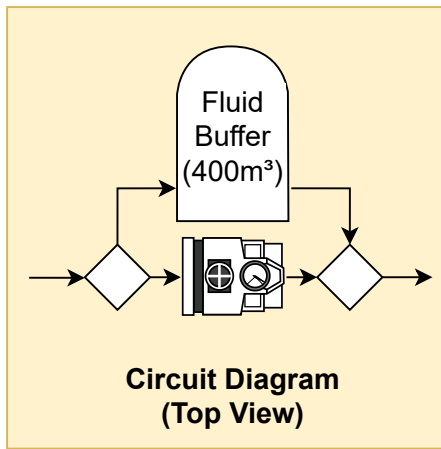

The Equalizer is a special circuit that **reduces Flow Rate fluctuations**.

When connected, it will try to reduce heavy fluctuations by storing fluid when there is too much and discharging when there is too little.

The Valve limit stays untouched.
If you think the circuit is too unstable, try adding Pipeline Pumps to the Input and Output.

Usage Example:

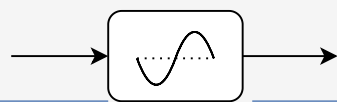

30-150
m³/min

65-115
m³/min

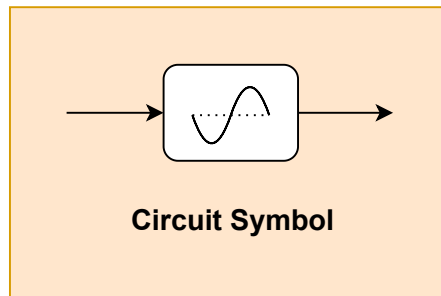

The main usage for this is really just for neatness:

if you find a fluctuating pipe, you can use this circuit to stabilize it and make it easier to read the proper Flow Rate.



Flow Compensator
(sample build)

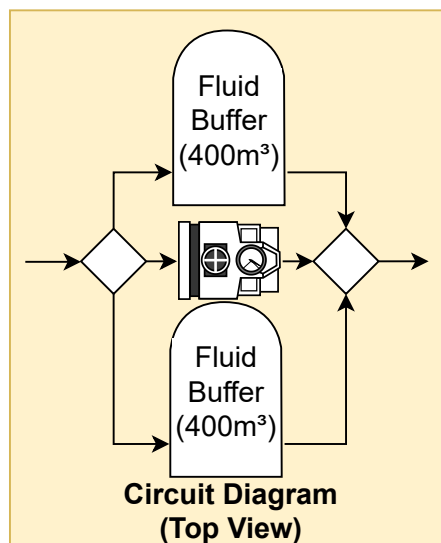

The Compensator is an **improved version of the Equalizer**.
(You could call it the Equalizer Mk. 2)

When connected, it reduces fluctuations even more than the Equalizer, **but is also much slower and a bit unstable**.

The Valve limit stays untouched.
If you think the circuit is too unstable, try adding Pipeline Pumps to the Input and Output.

Usage Example:

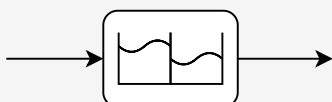

30-150
m³/min

~ 90
m³/min

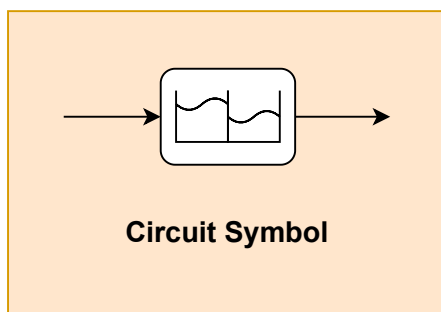

The Compensator has a usage case similar to the Equalizer: neatness.

Even the super dynamic Mk. 2 Pipes, who often have wildy fluctuating Flow Rates, can be tamed by the Compensator.

(It's not accurate to call these pipe builds "circuits", but it's easier to refer to them that way)

Lesson 11: Special Circuits - Variable Priority Junctions



Variable Input Priority [VIP] Junction (sample build)

The VIP is a circuit that **prioritizes the lowest input.**

When connected, it will **allow the pipe at the very bottom to flow freely**, while blocking the upper ones (unless the output allows more Flow).

Remember to power the Pumps!

For varying priorities, use more inputs by extending the VIP upwards.

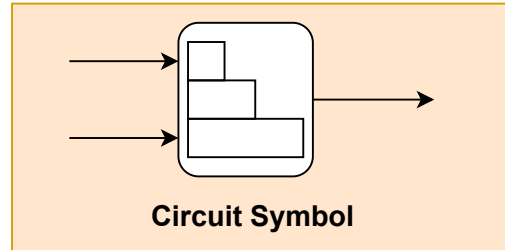
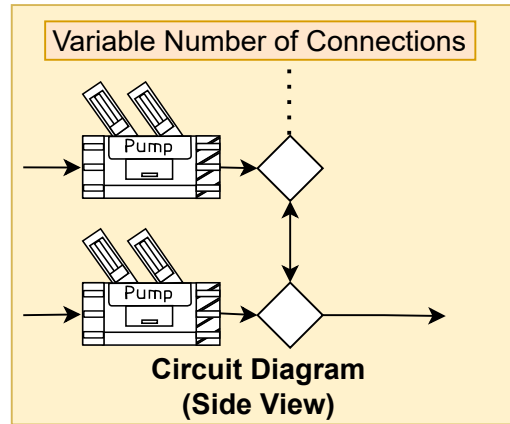

Feel free to change the number of inputs and outputs!
(Minimum: 2 Input, 1 Output)



Variable Output Priority [VOP] Junction (sample build)

The VOP is a circuit that **prioritizes the lowest output.**

When connected, it will **try to fill the output pipe at the very bottom first**. Once that is full, it will fill the next highest.

The VOP is basically just an expanded **Overflow Junction**.

For varying priorities, use more outputs by extending the VOP upwards.

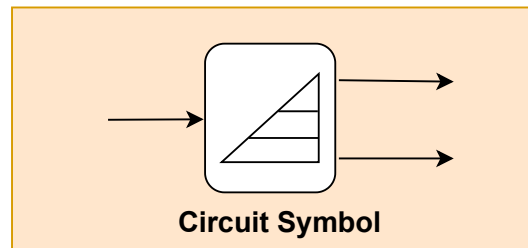
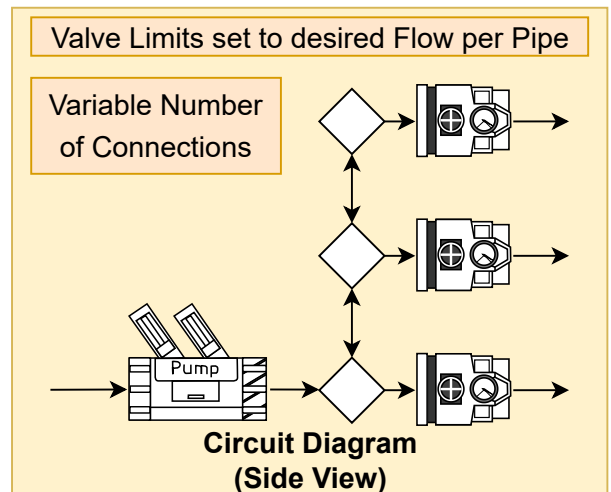

Feel free to change the number of inputs and outputs!
(Minimum: 1 Input, 2 Outputs)

Both of these circuits can be combined into one for **Input and Output Priority!**

Lesson 12: Special Circuits - Head Lift Tricks

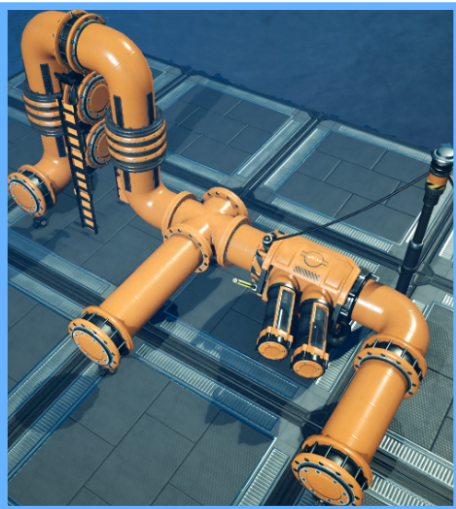

Overflow Junction (sample build)

The Overflow Junction allows any flow that doesn't fit in the bottom pipe to be diverted.

When connected, it will only become active once the bottom exit becomes backed up - then any extra flow moves over the little "heap"

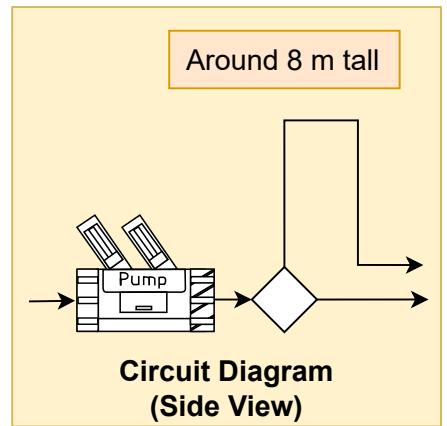

The Pump is here to give the fluid enough Head Lift to move over the heap no matter what.

The fluid will still only flow over the heap once the bottom exit backs up

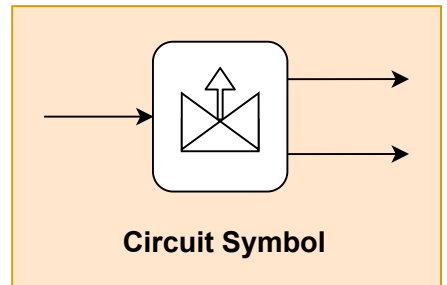

Water Tower (sample build)

The Water Tower allows pipes connected to it to run without Pumps.

When connected, as long as the pipes run below the buffer, no pumps will be needed.

If the Valve isn't used, the tower needs to constantly be filled.

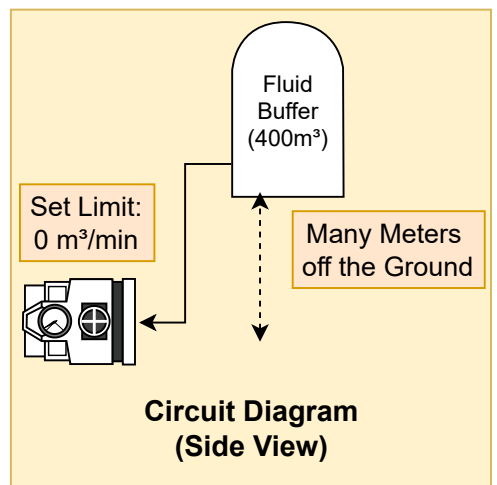

Two-way Pump (sample build)

The Two-Way Pump allows fluids to move both up and down.

When connected, it gives the pipe connected to it Head Lift to rise, but does not prevent backflow.

It works really well in combination with the Water Tower, as it will still allow backflow during blackouts.

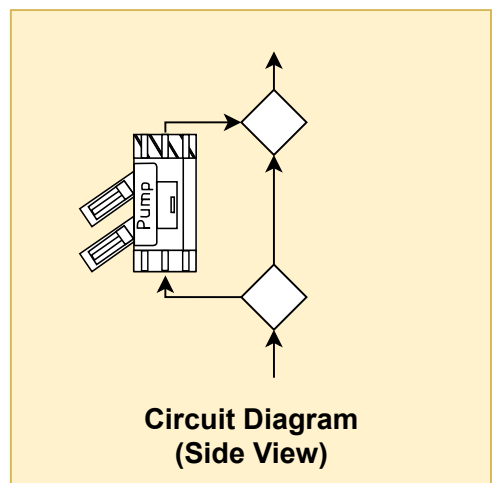

Lesson 13: Special Circuits - Sample Solutions

Example: Solving Water Backup in Aluminum Processing with a VIP Junction

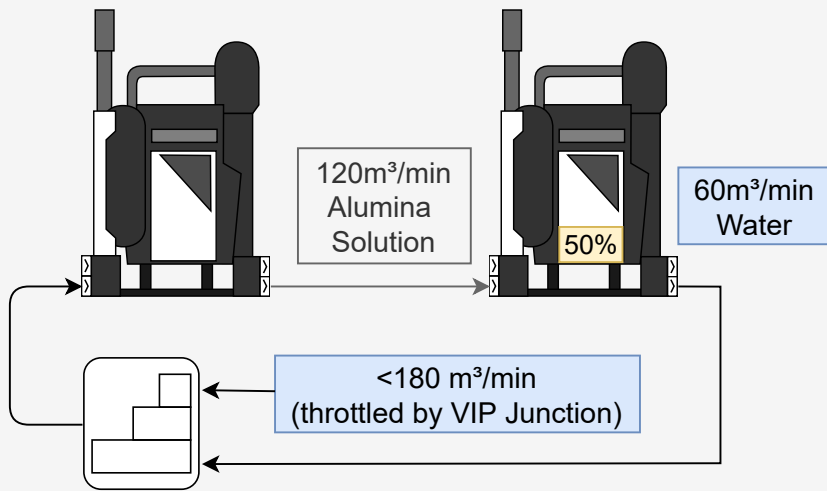

Example: Prioritizing Fuel Generators, then filling the Packager

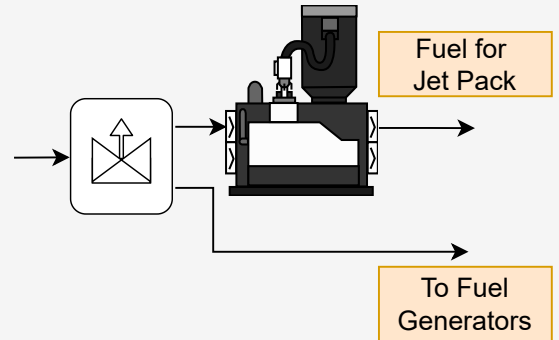

Example: Filling up Fuel Generators by flooding the pipes

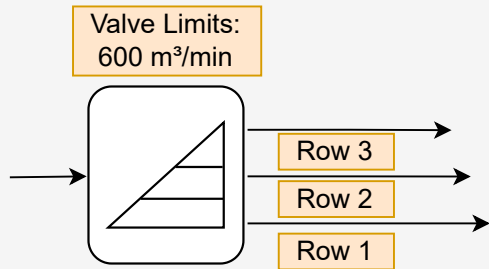

Example: Using a Water Tower to raise many pipes at once

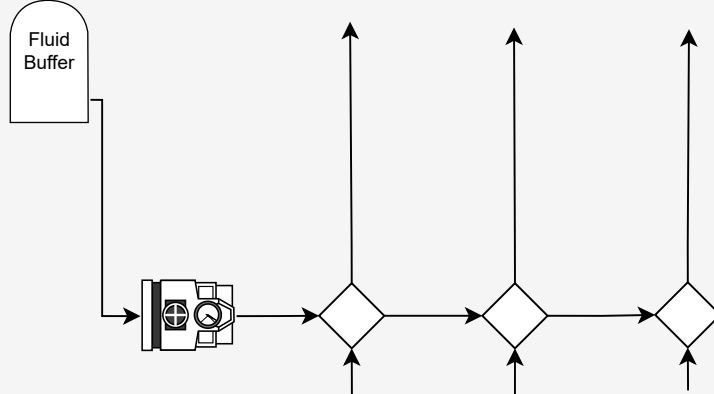

These are only the most useful *Special Circuits*. There are a few more, but they are not practical for the general factory purposes of FICSIT Pioneers.

Upon further request, this manual will be expanded with more information on Pipeline mechanics.

Hopefully, this Manual could help you solve some of your factory issues or answer some of your questions.